

# BUREAU OF HIGHWAY DESIGN

## September 1, 2022

**Bill Oldenburg**  
ASSISTANT DIRECTOR  
PROJECT DEVELOPMENT

**Jim Marshall**  
ADMINISTRATOR CE7

**ADMINISTRATION**

**Vacant**  
Administrative Assistant 1

**COMPUTER SUPPORT**

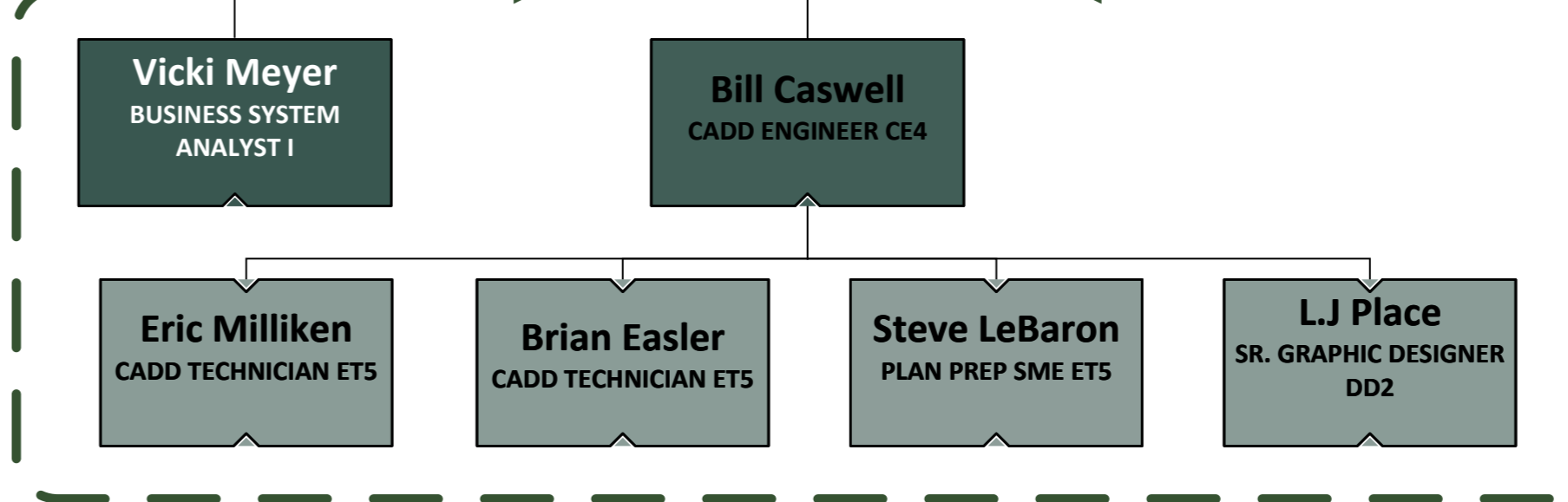

**PROJECT MANAGEMENT**

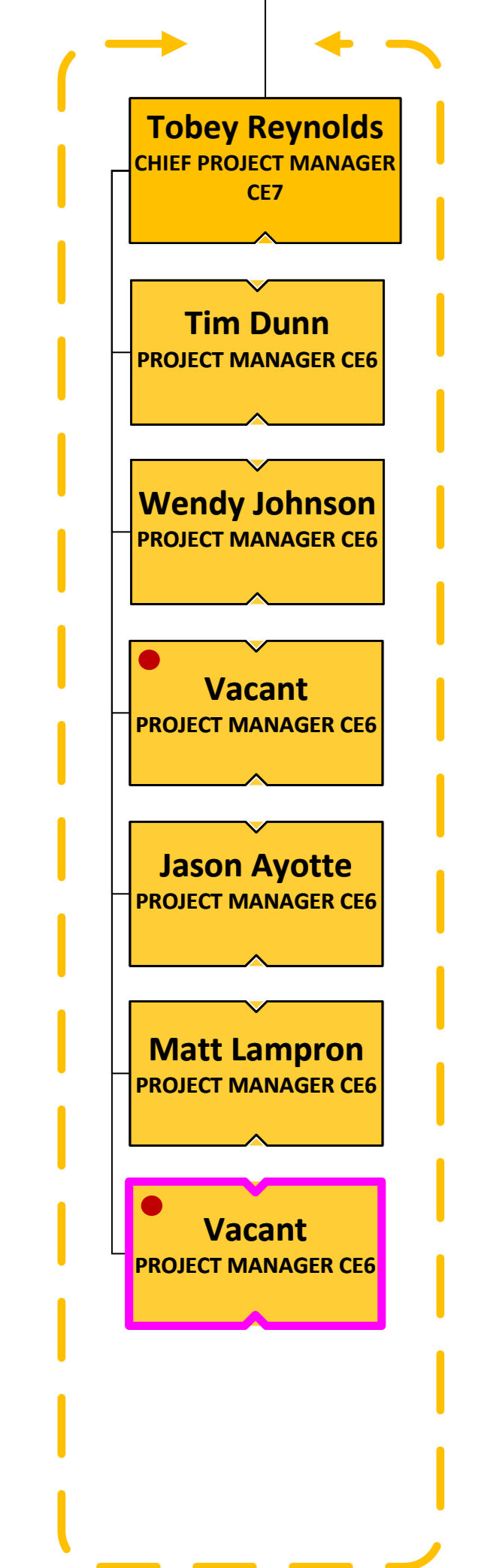

**ROADWAY SECTION**

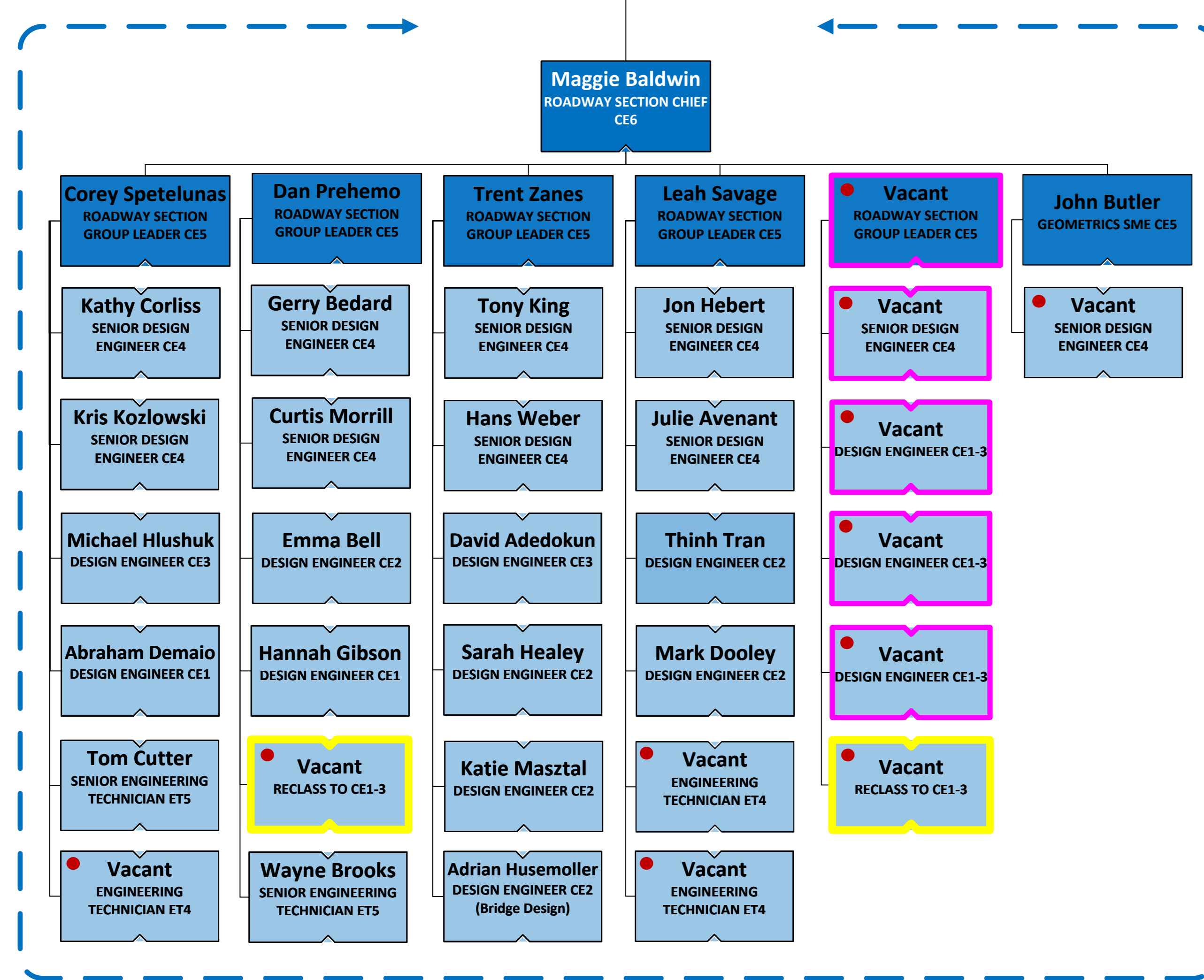

**PAVEMENT SECTION**

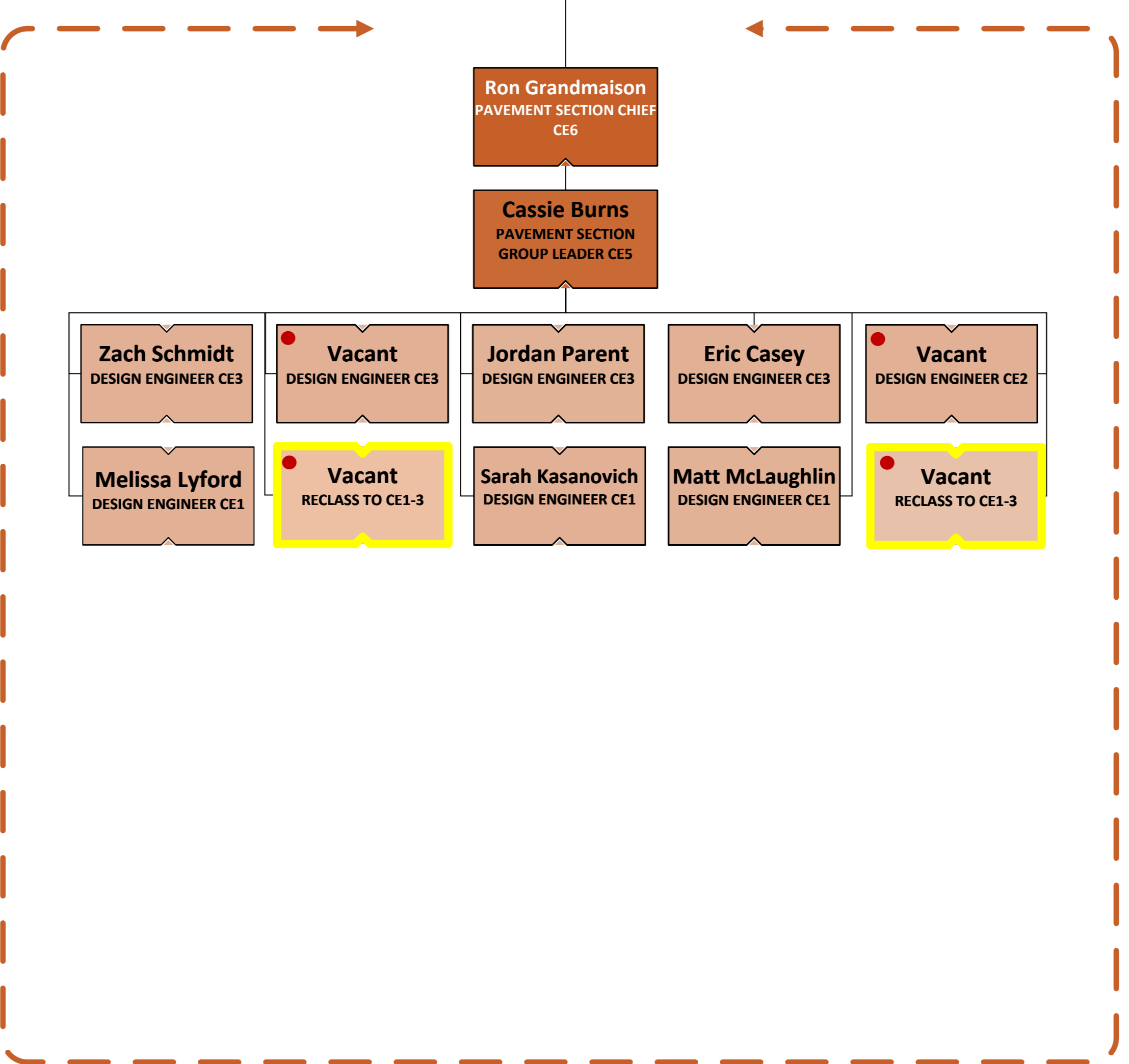

**SAFETY SECTION**

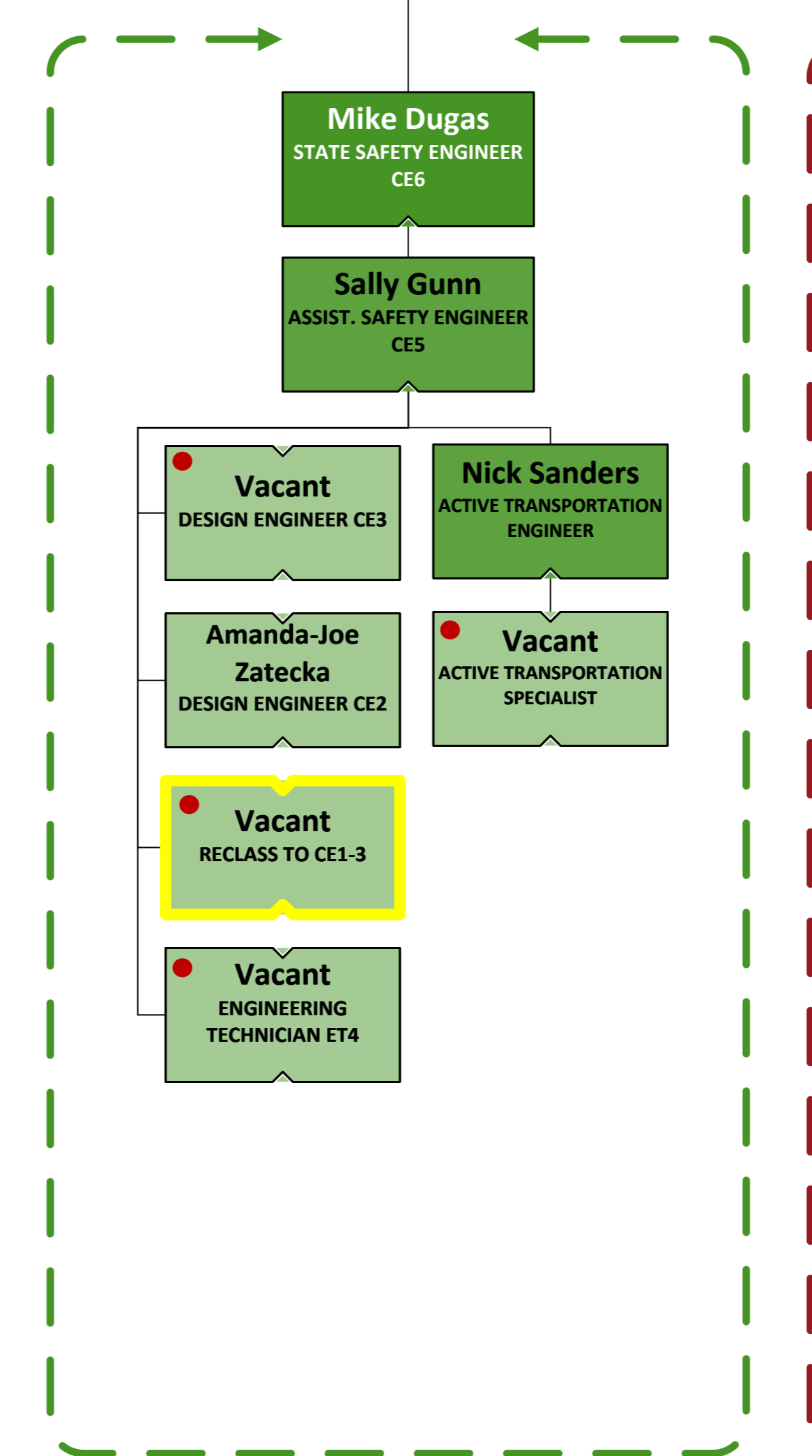

**SPECIALTY SECTION**

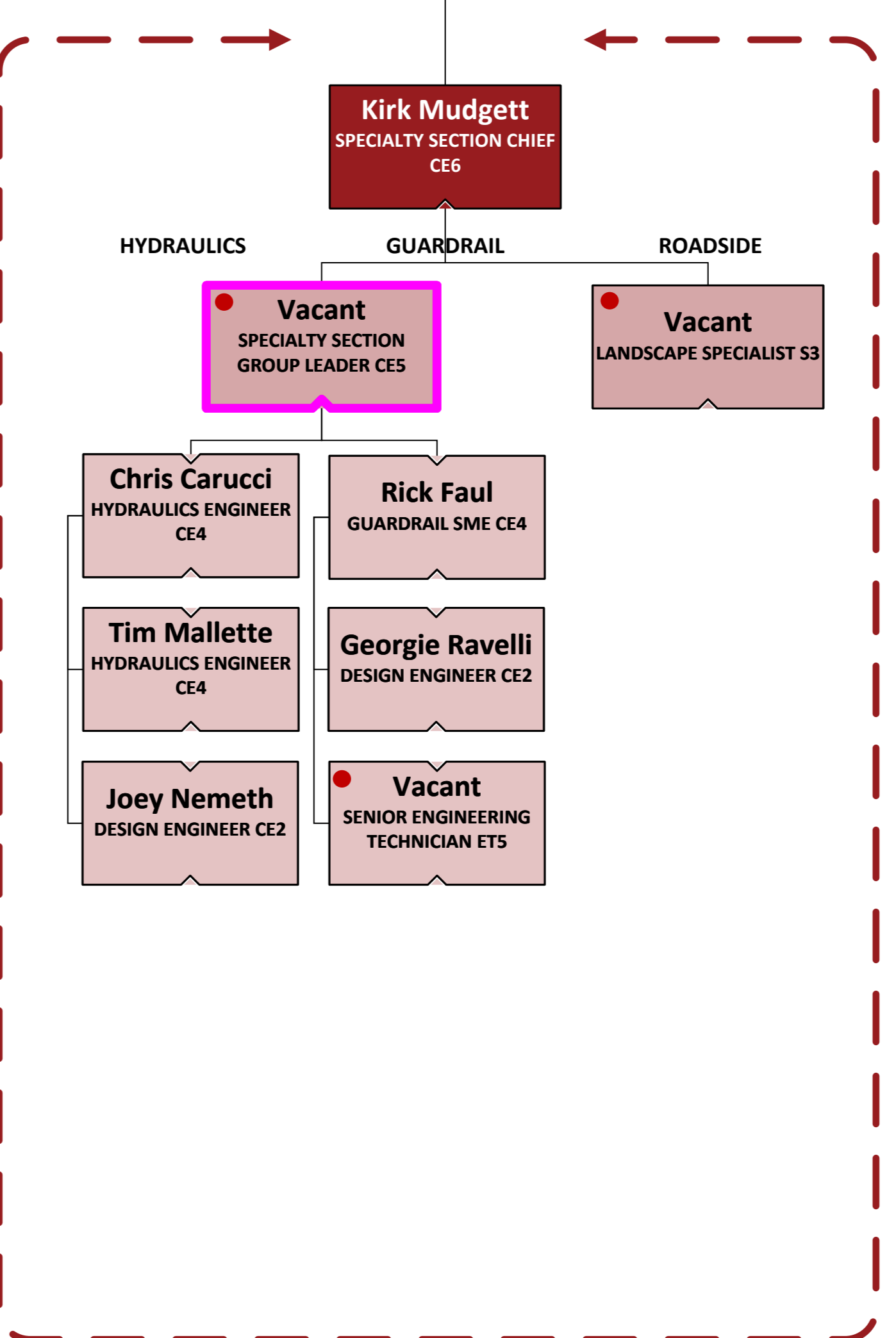

**DESIGN SERVICES**

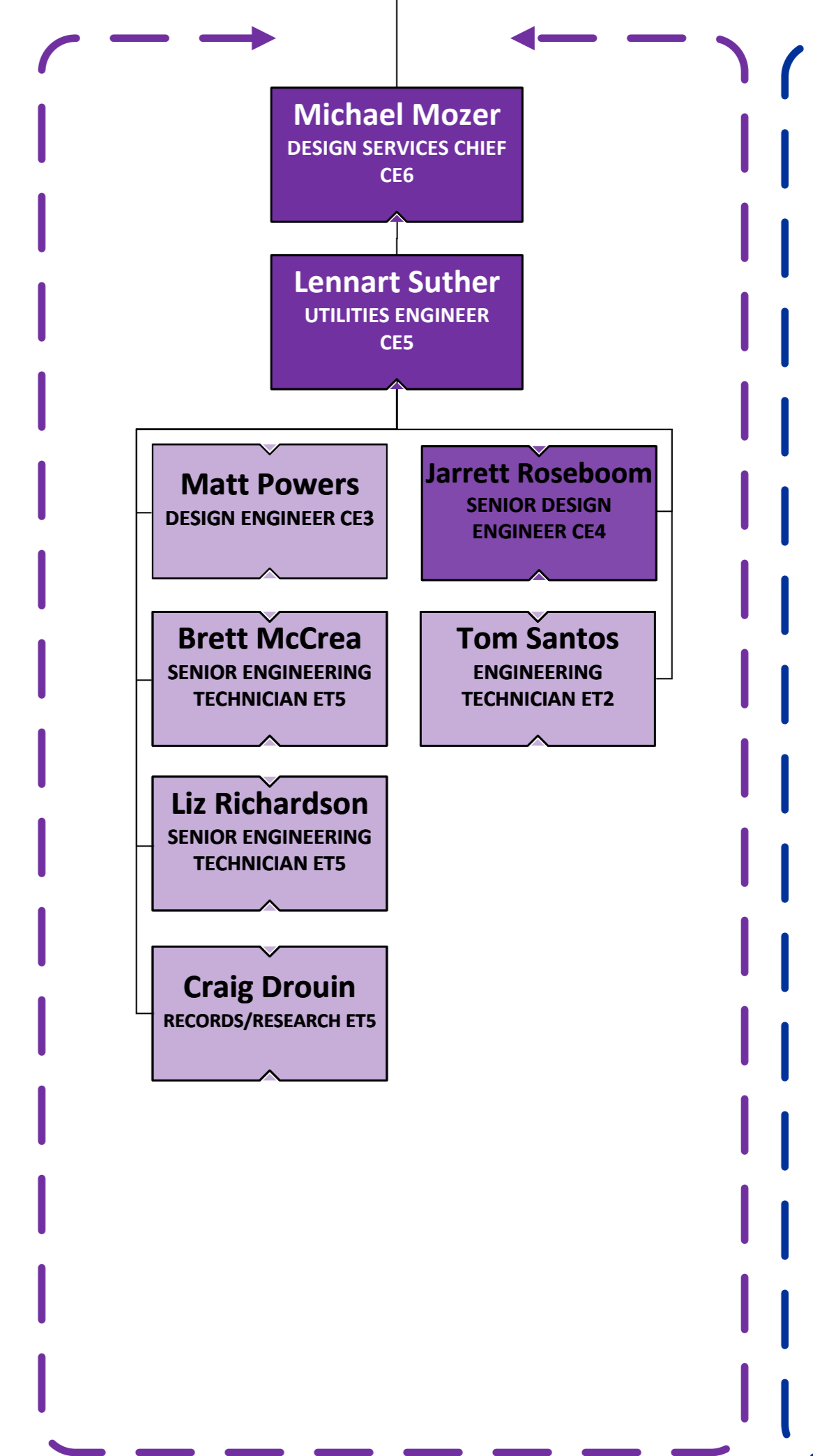

**CONTRACT & SPECIFICATIONS SECTION**

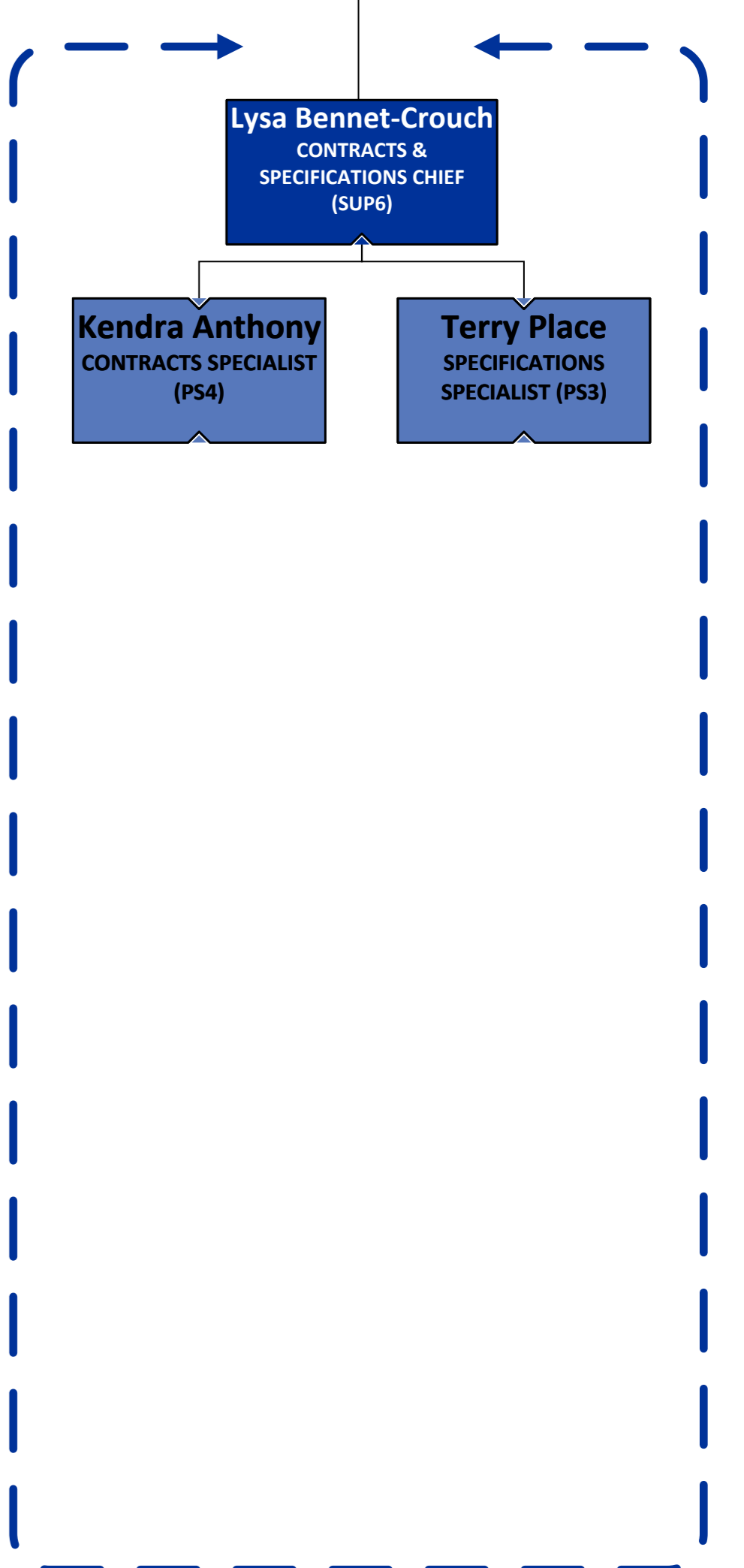

**Vacant** SECRETARY II

Engineering Aide I SNL 3334, LG 6 Bur/For 3411

Engineering Aide I SNL 3335, LG 6 Bur/For 3411

Engineering Technician II TMPPT 1256, LG 13 Bur/For 3411

Civil Engineer III TMPPT 2137, LG 24 Bur/For 3411